

# Dimensions

## Frame C

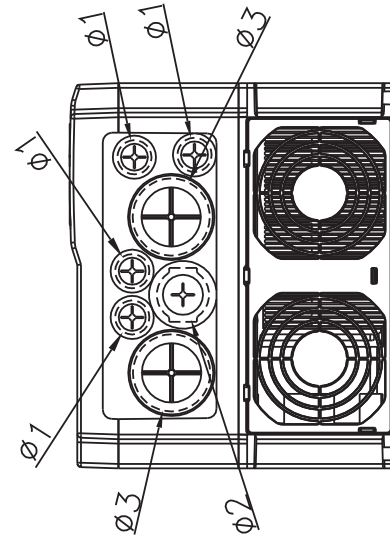

Detail A (Mounting Hole)

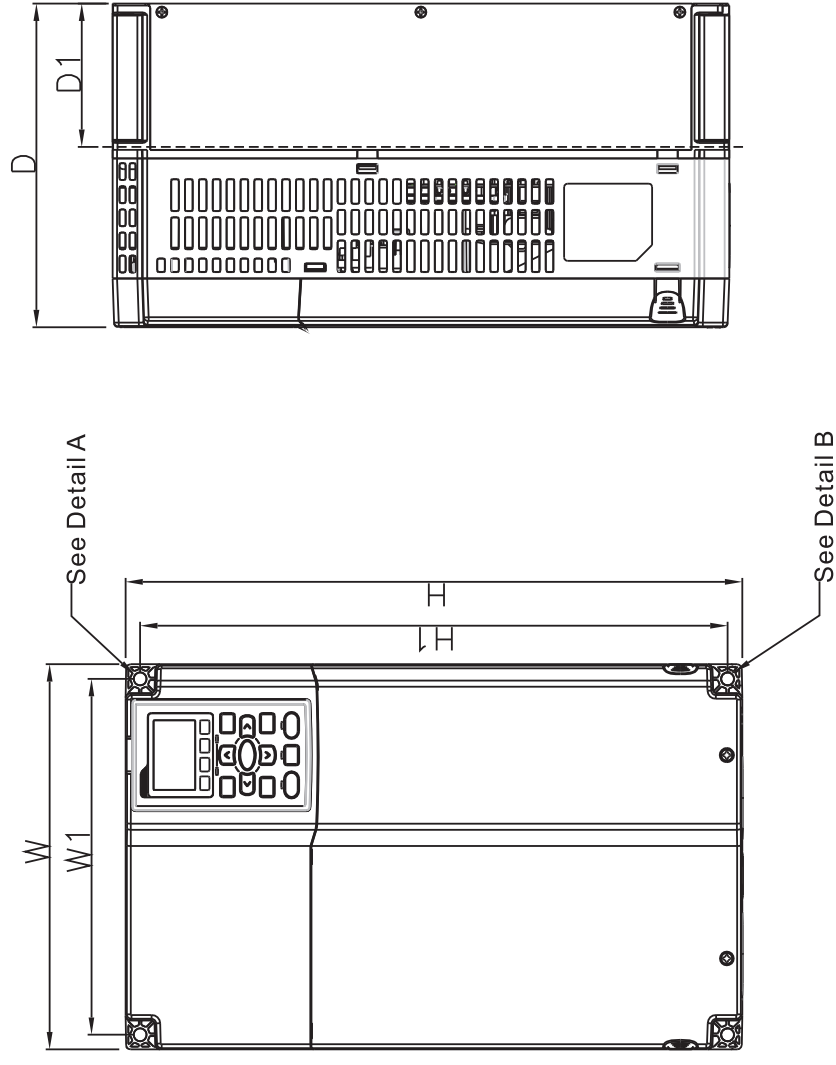
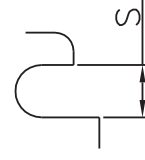

Detail B (Mounting Hole)

**MODEL**  
 VFD150C23A  
 VFD185C23A  
 VFD185C43A/43E  
 VFD220C23A  
 VFD220C43A/43E  
 VFD300C43A/43E

Frame	W	H	D	W1	H1	H2	D1*	S1	$\phi 1$	$\phi 2$	$\phi 3$
C1	mm	250.0	400.0	210.0	231.0	381.0	92.9	8.5	22.2	34.0	50.0
	inch	9.84	15.75	8.27	9.09	15.00	3.66	0.33	0.87	1.34	1.97

Unit : mm[inch]  
 D1\* : Flange mounting

## Frame D

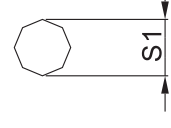
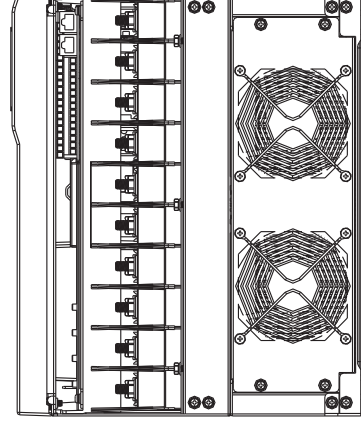
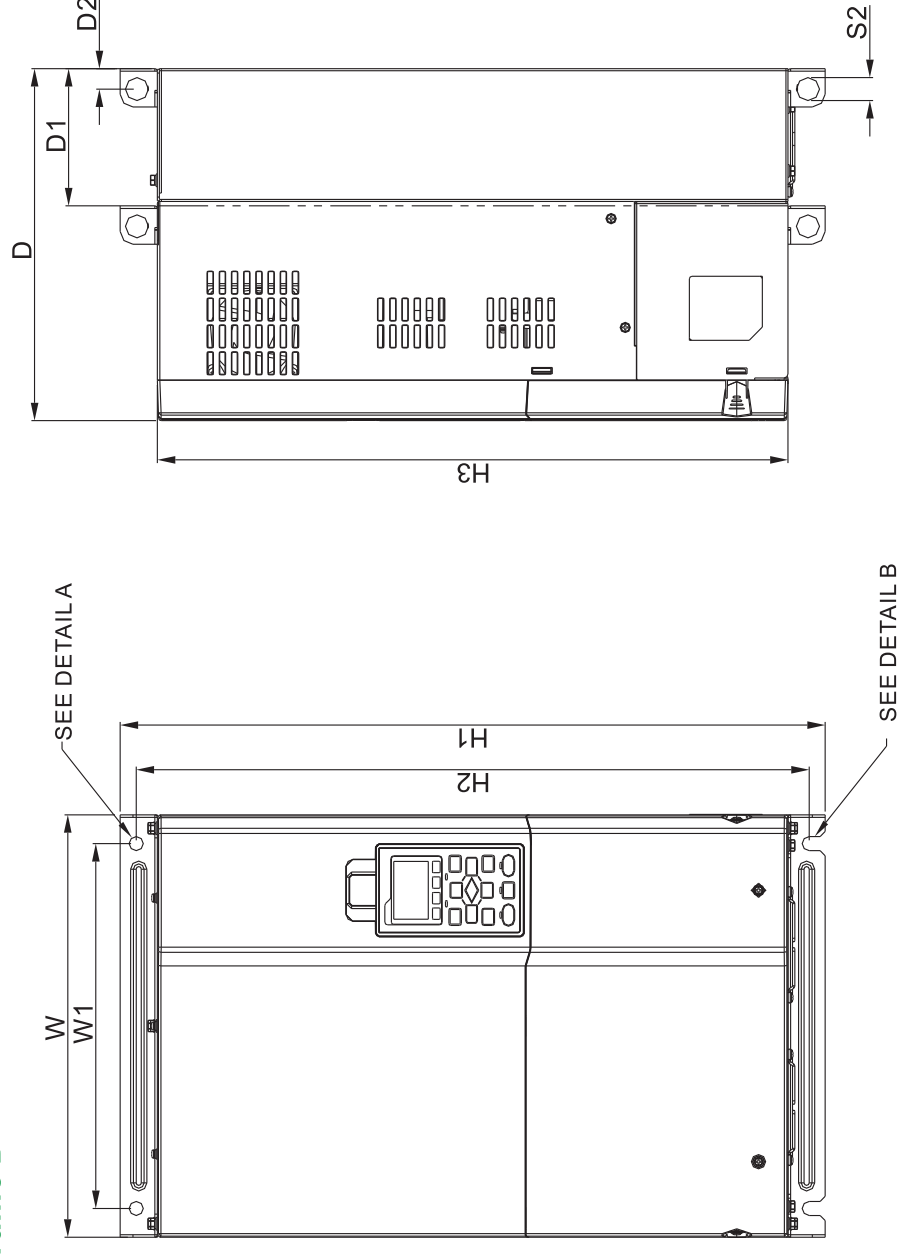

DETAIL A  
(MOUNTING HOLE)

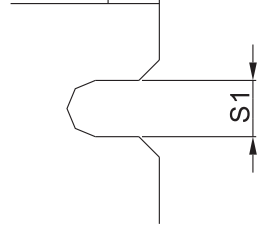

DETAIL B  
(MOUNTING HOLE)

**MODEL**  
**FRAME D1**  
 VFD300C23A  
 VFD370C23A  
 VFD370C43A  
 VFD450C43A  
 VFD550C43A  
 VFD750C43A

Frame	W	H	D	W1	H1	H2	H3	D1*	D2	S1	S2	$\phi 1$	$\phi 2$	$\phi 3$
D1	mm	330.0	-	275.0	285.0	550.0	492.0	107.2	16.0	11.0	18.0	-	-	-
	inch	12.99	-	10.83	11.22	21.65	20.67	4.22	0.63	0.43	0.71	-	-	-

Unit : mm[inch]  
 D1\* : Flange mounting